



**FEATURES:**

- Plastic package has Underwriters Laboratory Flammability Classification 94V-0
- Ideally suited for freewheeling diode power factor correction applications
- Excellent high temperature switching
- Optimized to reduce switching losses
- High temperature soldering guaranteed : 250°C / 10 second, 0.25" (6.35mm) from case

**MECHANICAL DATA**

Case : JEDEC ITO-220AC molded plastic  
 Terminals : Leads solderable per MIL-STD-750 Method 2026  
 Position : As marked  
 Mounting Position : Any  
 Mounting Torque : 5 in -lbs.max  
 Weight : 0.08 ounce, 2.24grams

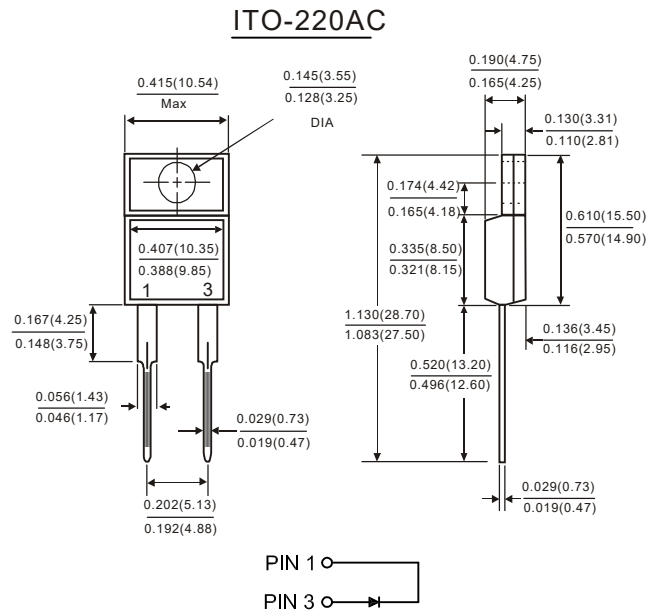

Dimensions in inches and (millimeters)

**MAXIMUM RATINGS AND ELECTRICAL CHARACTERISTICS**

Rating at 25 °C ambient temperature unless otherwise specified.  
 Single phase half wave, 60 Hz resistive or inductive load.  
 For capacitive load, derate current by 20%.

Characteristic	Symbol	SFF 16005	SFF 1601	SFF 1602	SFF 1603	SFF 1604	SFF 1606	Units
Maximum recurrent peak reverse voltage	$V_{RRM}$	50	100	200	300	400	600	Volts
Maximum RMS voltage	$V_{RMS}$	35	70	140	210	280	420	Volts
Maximum DC blocking voltage	$V_{DC}$	50	100	200	300	400	600	Volts
Maximum average forward rectified current at $T_c=100^\circ C$ (Per Pak)	$I_{(AV)}$	16.0						Amps
Peak forward surge current 8.3ms single half sine-wave superimposed on rated load (JEDEC Method)(Per leg)	$I_{FSM}$	200						Amps
Maximum instantaneous forward voltage (Per leg) $I_F=16A$	$V_F$	1.0		1.30		1.70		Volts
Maximum DC reverse current at rated DC blocking voltage (Per leg) $T_c=25^\circ C$ $T_c=125^\circ C$	$I_R$	10.0 500.0						$\mu A$
Typical reverse recovery time (NOTE 1)(Per leg)	$T_{RR}$	35						nS
Typical junction capacitance (NOTE 2)(Per leg)	$C_J$	175					145	$P_F$
Operating temperature range	$T_J$	-55to+150						$^\circ C$
Storage temperature range	$T_{Stg}$	-55to+150						$^\circ C$

- NOTES:  
 (1) Reverse Recovery Test CONDITION :  $I_F=0.5A, I_R=1.0A, I_{RR}=0.25A$   
 (2) Measured at 1MHZ and reverse Voltage of 4.0V  
 (3) Marking : SF16005CT = SF16005 (Without Marking "CT")  
                   Symbol            Marking



## RATINGS AND CHARACTERISTIC CURVES

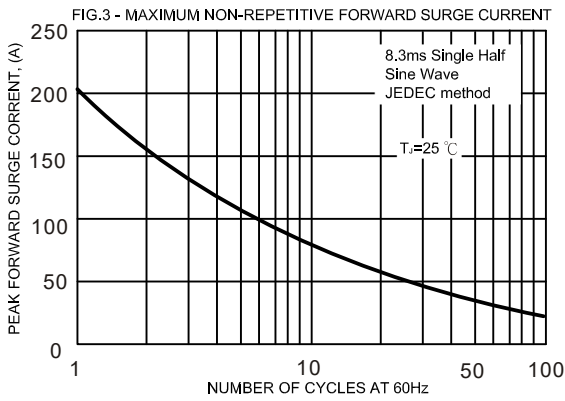
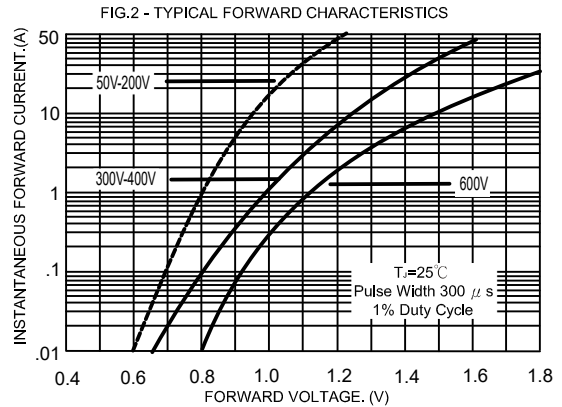
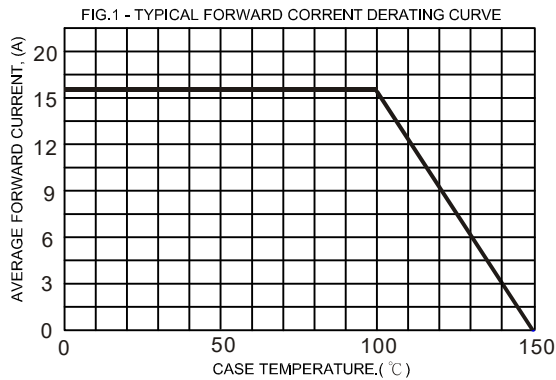
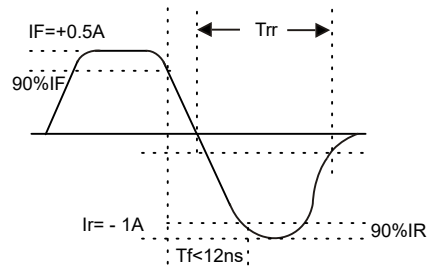
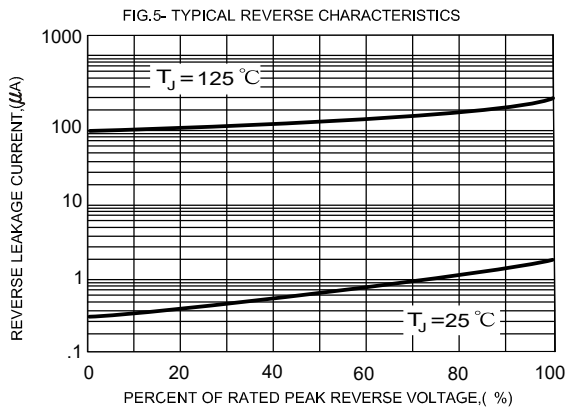
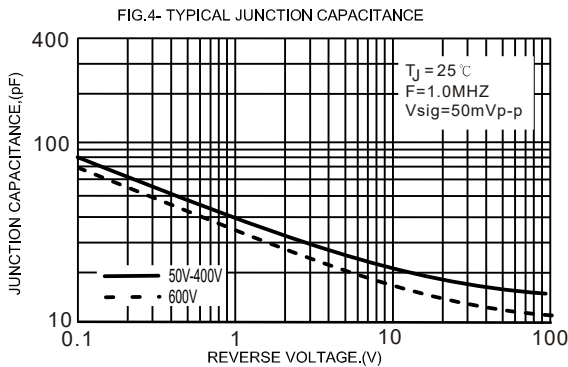
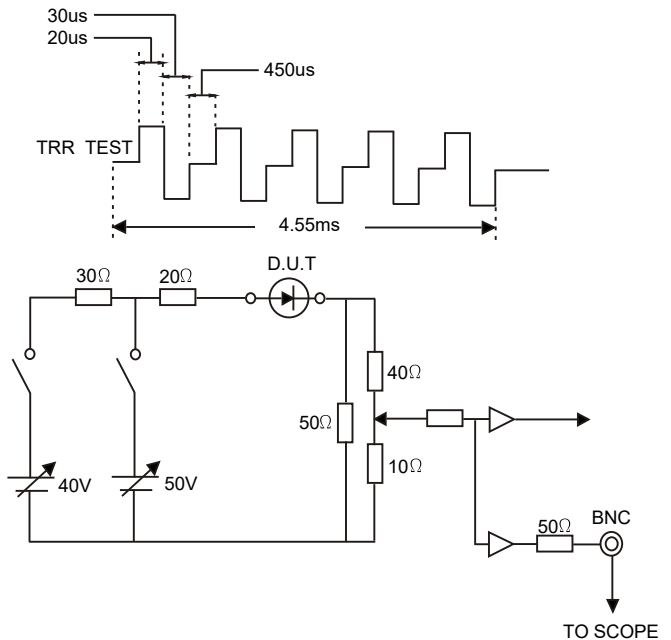

Figure 6 GR1 Test Circuit





## **Disclaimer**

DACO Semiconductor reserves the right to make modifications, enhancements, improvements, corrections, or other changes to this document and any product described herein without prior notice.

DACO Semiconductor makes no warranty, representation, or guarantee regarding the suitability of its products for any particular purpose, nor does DACO Semiconductor assume any liability arising out of the application or use of any product or circuit, and specifically disclaims any liability, including without limitation special, consequential or incidental damages.

Purchasers are responsible for its products and applications using DACO Semiconductor products, including compliance with all laws, regulations, and safety requirements or standards, regardless of any support or application information provided by DACO Semiconductor. "Typical" parameters that may be provided in DACO Semiconductor datasheets and/or specifications can and do vary in different applications and actual performance may vary over time. All operating parameters, including "Typical" must be validated for each customer application by the customer's technical experts.

DACO Semiconductor products are not designed, authorized, or warranted to be suitable for use in life support, life-critical or safety-critical systems, or equipment, nor in applications where failure or malfunction of DACO Semiconductor's product can reasonably be expected to result in personal injury, death or severe property or environmental damage. DACO Semiconductor accepts no liability for the inclusion and/or use of DACO Semiconductor's products in such equipment or applications and therefore such inclusion and/or use is at the customer's own risk.

Purchasers who buy or use DACO Semiconductor products for any unintended or unauthorized applications are required to indemnify and absolve DACO Semiconductor, its suppliers, and distributors from any claims, costs, damages, expenses, and reasonable attorney fees arising out of, directly or indirectly, any claim of personal injury or death associated with such unintended or unauthorized use, even if such claim alleges that DACO Semiconductor was negligent regarding the design or manufacture of the part.

No part of this publication may be reproduced or transmitted in any form or by any means, electronic or mechanical, including photocopying and recording, or by any information storage and retrieval system, or otherwise, without the prior written permission of DACO Semiconductor Co., Ltd.