



SUPER FAST GLASS PASSIVATED RECTIFIERS

FEATURES:

- Low forward voltage drop
- High current capability
- High reliability
- High surge current capability
- Good for switching mode application

MECHANICAL DATA

Case : Molded plastic
 Epoxy: UL 94V-0 rate flame retardant
 Lead : Axial leads, solderable per MIL-STD-202,
 Method 208 guaranteed
 Polarity : Color band denotes cathode end
 Mounting Position : Any
 Weight : 1.10 grams

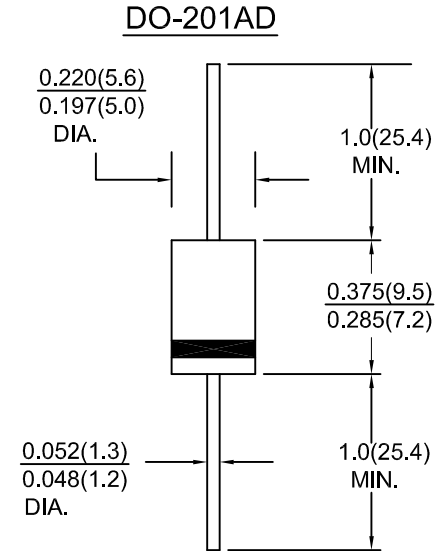

Dimensions in inches and (millimeters)

MAXIMUM RATINGS AND ELECTRICAL CHARACTERISTICS

Rating at 25°C ambient temp. unless otherwise specified.
 Single phase, half sine wave, 60 Hz, resistive or inductive load.
 For capacitive load, derate current by 20 %.

Characteristic	Symbol	SF 51G	SF 52G	SF 53G	SF 54G	SF 55G	SF 56G	SF 57G	Units
Maximum recurrent peak reverse voltage	VRRM	50	100	150	200	300	400	600	Volts
Maximum RMS voltage	VRMS	35	70	105	140	210	280	420	Volts
Maximum DC blocking voltage	VDC	50	100	150	200	300	400	600	Volts
Maximum average forward rectified current .375"(9.5mm) lead length at Ta=55°C	I(AV)	5.0							Amps
Peak forward surge current ,8.3ms single half sine-wave superimposed on rated load(JEDEC Method)	IFSM	150							Amps
Maximum instantaneous forward voltage at 5.0 A	VF	1.00			1.30		1.70		Volts
Maximum DC reverse current at rated DC blocking voltage Ta=25°C Ta=125°C	IR	5.0			100				μ A
Maximum reverse recovery time (note 1)	trr	35							nS
Typical junction capacitance (note 2)	Cj	50							pF
Operating and storage temperature range	Tj, Tstg	-65 to +150							°C

Notes : 1. Reverse recovery test condition : I_F=0.5A ; I_R=1.0A ; I_{RR}=0.25A
 2. Measured 1MHz and applied reverse voltage of 4.0V DC



RATINGS AND CHARACTERISTIC CURVES

FIG.1-TEST CIRCUIT DIAGRAM AND REVERSE RECOVERY TIME CHARACTERISTIC

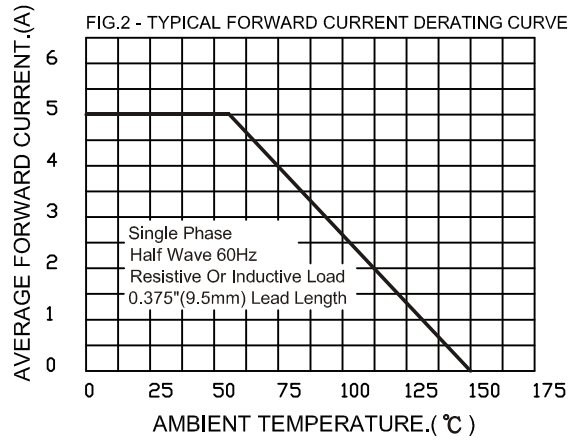
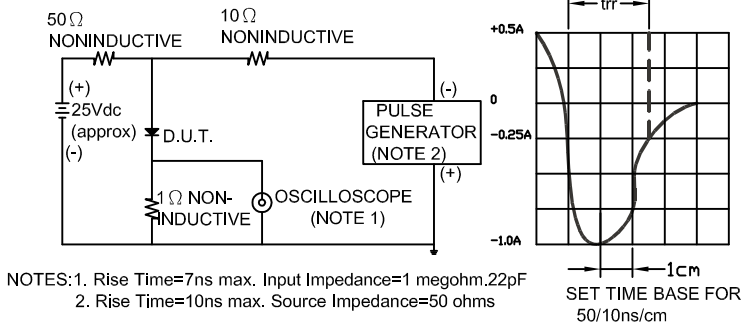

FIG.3-TYPICAL FORWARD CHARACTERISTICS

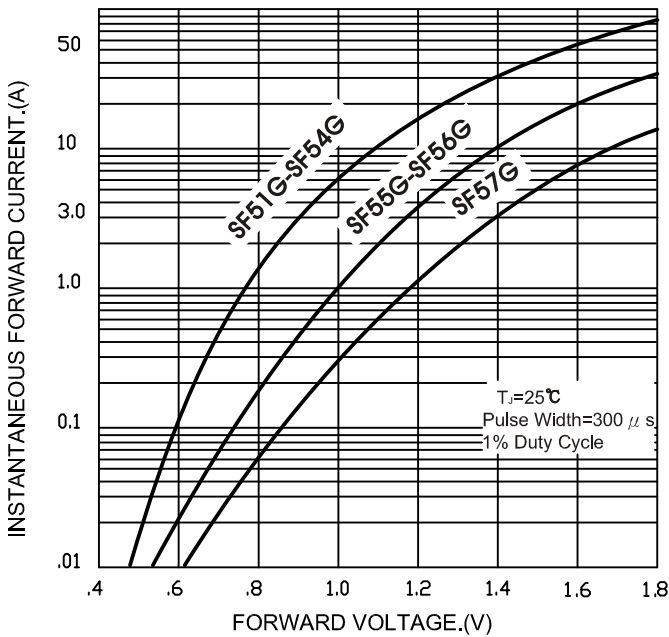

FIG.4-TYPICAL REVERSE CHARACTERISTICS

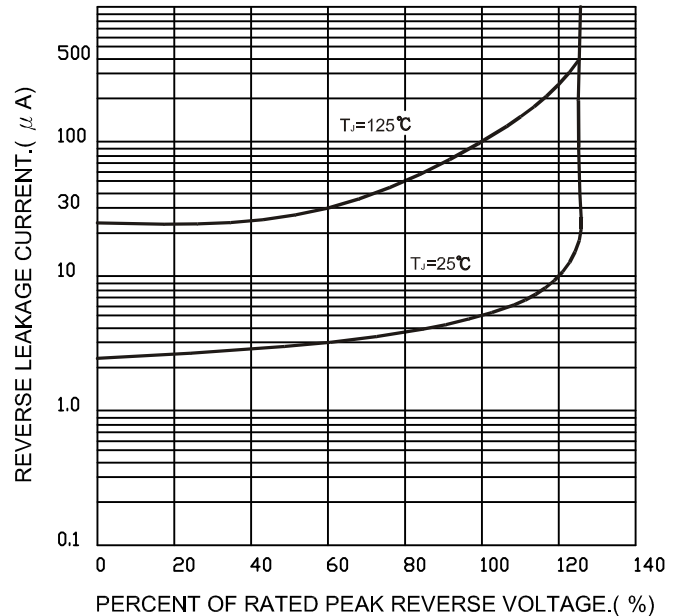

FIG.5-MAXIMUM NON-REPETITIVE FORWARD SURGE CURRENT

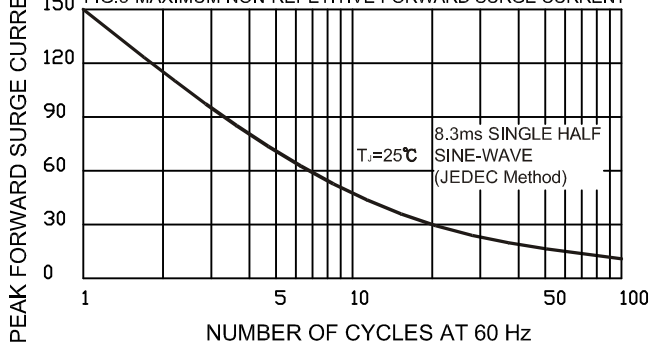
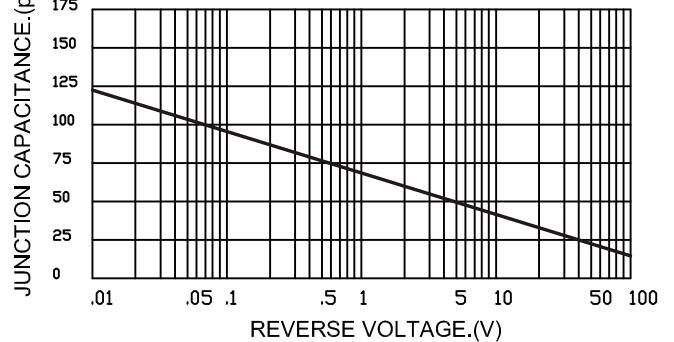

FIG.6-TYPICAL JUNCTION CAPACITANCE





Disclaimer

DACO Semiconductor reserve the right to make modifications, enhancements, improvements, corrections or other changes without further notice to this document and any product described herein.

DACO Semiconductor makes no warranty, representation or guarantee regarding the suitability of its products for any particular purpose, nor does DACO Semiconductor assume any liability arising out of the application or use of any product or circuit, and specifically disclaims any and all liability, including without limitation special, consequential or incidental damages.

Purchasers is responsible for its products and applications using DACO Semiconductor products, including compliance with all laws, regulations and safety requirements or standards, regardless of any support or applications information provided by DACO Semiconductor. "Typical" parameters which may be provided in DACO Semiconductor data sheets and/or specifications can and do vary in different applications and actual performance may vary over time. All operating parameters, including "Typicals" must be validated for each customer application by customer's technical experts.

DACO Semiconductor products are not designed, authorized or warranted to be suitable for use in life support, life-critical or safety-critical systems or equipment, nor in applications where failure or malfunction of DACO Semiconductor's product can reasonably be expected to result in personal injury, death or severe property or environmental damage. DACO Semiconductor accept no liability for inclusion and/or use of DACO Semiconductor's products in such equipment or applications and therefore such inclusion and/or use is at the customer's own risk.

Purchasers buy or use DACO Semiconductor products for any such unintended or unauthorized application, Purchasers shall indemnify and hold DACO Semiconductor and its suppliers and distributors harmless against all claims, costs, damages, and expenses, and reasonable attorney fees arising out of, directly or indirectly, any claim of personal injury or death associated with such unintended or unauthorized use, even if such claim alleges that DACO Semiconductor was negligent regarding the design or manufacture of the part.

No part of this publication may be reproduced or transmitted in any form or by any means, electronic or mechanical, including photocopying and recording, or any information storage or retrieval system, or otherwise, without the prior written permission of DACO Semiconductor Co., Ltd.