



SiC SCHOTTKY DIODE TYPE 30A

Features

- High surge current capable
- Zero reverse recovery current
- High bandwidth
- RoHS compliant
- Temperature Independent Switching Behavior
- High temperature soldering guaranteed: 260°C / 10 seconds at terminals
- VDC 1200 V
- I_F (T_c<150°C) 30 A

Benefits

- Unipolar rectifier
- Zero switching loss
- Higher efficiency
- Smaller heat sink
- Parallel devices without thermal runaway

Applications

- Motor drives
- Switch mode power supplies
- Ev chargers
- Solar inverters
- Welding equipment
- Power factor correction
- Diode snubber
- Automotive
- induction heating

Maximum Ratings

Operating Junction Temperature : - 55 °C to +175 °C

Storage Temperature : -55 °C to +175 °C

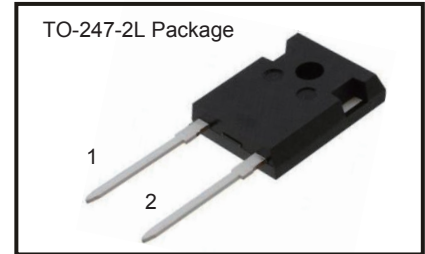

Package Dimensions

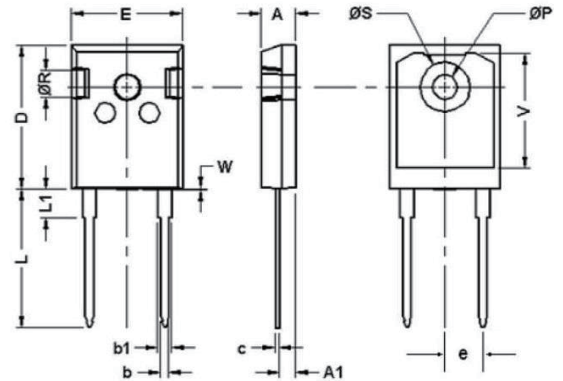

Part Number	Maximum Recurrent Peak Reverse Voltage	Maximum DC Blocking Voltage
CSR30121P	1200V	1200V

POS	Inches		Millimeters	
	Min	Max	Min	Max
A	0.185	0.209	4.70	5.31
A1	0.087	0.102	2.21	2.59
b	0.040	0.055	1.02	1.40
b1	0.065	0.088	1.65	2.23
C	0.016	0.031	0.41	0.79
D	0.819	0.845	20.80	21.46
E	0.61	0.640	15.49	16.26
e	0.215	0.215	5.46	5.46
L	0.78	0.80	19.81	20.32
L1	0.164	0.176	4.17	4.47
øP	0.140	0.144	3.56	3.66
Q	0.212	0.244	5.38	6.20
øR	0.135	0.157	3.43	3.99
øS	0.278	0.288	7.06	7.32
V	0.652	0.662	16.56	16.81
W	0.000	0.006	0.00	0.15

Maximum Rating	Symbol	Conditions	Value	Unit
Continuous forward current	I _F	T _C =150 °C	30	A
Surge non-repetitive forward current sine halfwave	I _{FSM}	T _C =25 °C, t _p =8.3 ms	240	
		T _C =150 °C, t _p =8.3 ms	150	
Non-repetitive peak forward current	I _{F,max}	T _C =25 °C, t _p =10 μs	600	
Repetitive peak reverse voltage	V _{RRM}	T _J =25 °C	1200	V

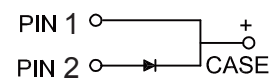



Electrical Characteristics, at $T_j=25\text{ }^\circ\text{C}$, unless otherwise specified.

Static Characteristics	Symbol	Conditions	Values			Unit
			min.	typ.	max.	
DC blocking voltage	V_{DC}		1200	-	-	V
Diode forward voltage	V_F	$I_F=30\text{A}, T_j=25\text{ }^\circ\text{C}$	-	1.6	1.8	
		$I_F=30\text{A}, T_j=175\text{ }^\circ\text{C}$	-	2.2	2.7	
Reverse current	I_R	$V_R=1200\text{V}, T_j=25\text{ }^\circ\text{C}$	-	5	60	μA
		$V_R=1200\text{V}, T_j=175\text{ }^\circ\text{C}$	-	170	1800	

AC Characteristics

Static Characteristics	Symbol	Conditions	Values			Unit
			min.	typ.	max.	
Total capacitive charge	Q_C	$V_R=1200\text{V}, T_j=25\text{ }^\circ\text{C}$	-	129	-	nC
Total capacitance	C	$V_R=1\text{V}, f=1\text{ MHz}$ $T_j=25\text{ }^\circ\text{C}$	-	1905	-	pF
		$V_R=600\text{V}, f=1\text{ MHz}$ $T_j=25\text{ }^\circ\text{C}$	-	111	-	
		$V_R=1200\text{V}, f=1\text{ MHz}$ $T_j=25\text{ }^\circ\text{C}$	-	108	-	

Thermal Characteristics

Static Characteristics	Symbol	Values	Unit
		typ.	
Thermal resistance from junction to case	$R_{\theta JC}$	0.30	$^\circ\text{C/W}$



Typical Performance

Forward Characteristics (parameterized on T_j)

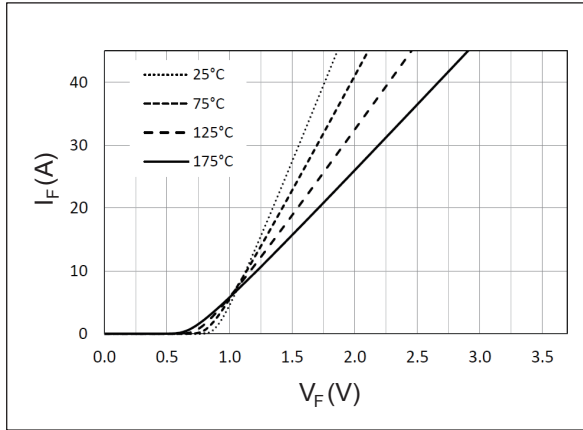

Reverse Characteristics (parameterized on T_j)

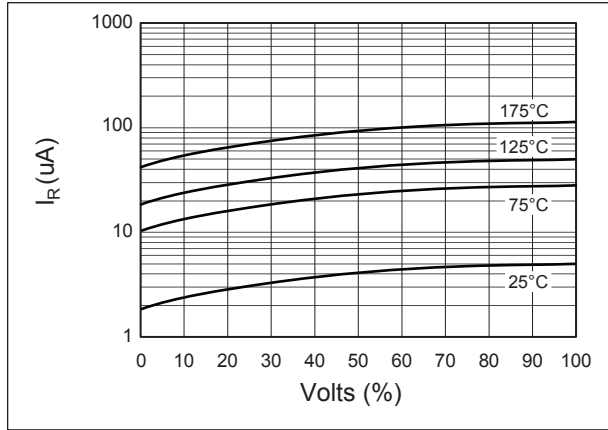

Capacitance

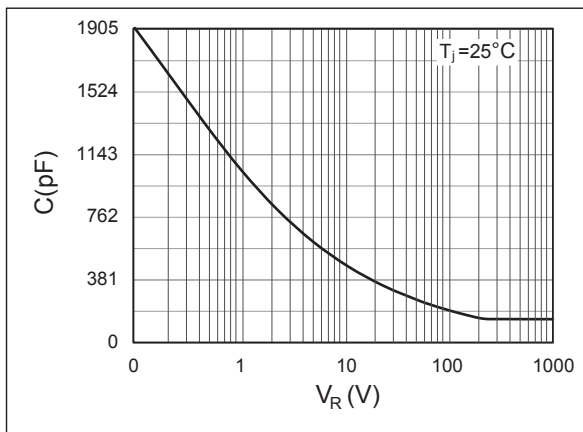

Current Derating

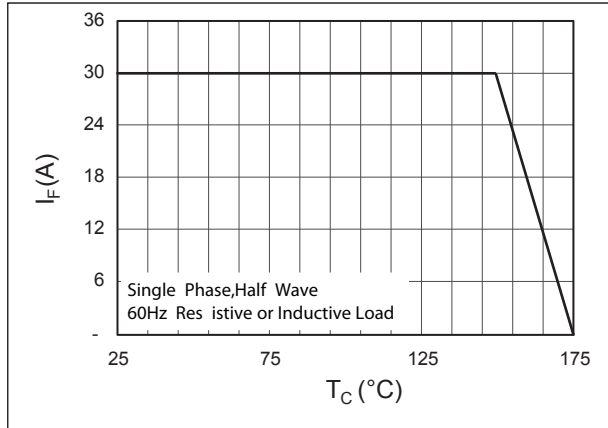

Recovery Charge

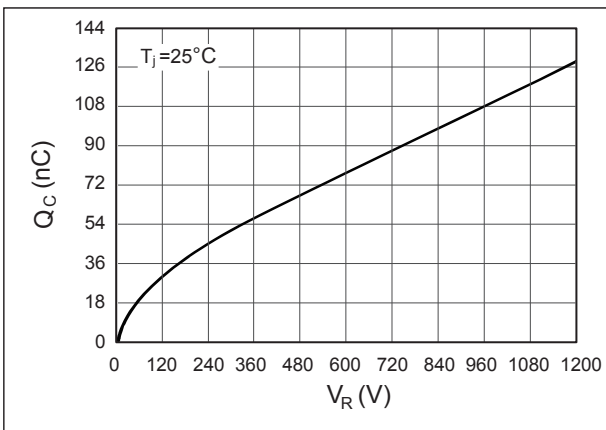

Forward Surge Current

