



SiC SCHOTTKY DIODE TYPE 20A

Features

- High surge current capable
- Zero reverse recovery current
- High bandwidth
- RoHS compliant
- Temperature Independent Switching Behavior
- High temperature soldering guaranteed: 260°C / 10 seconds at terminals
- VDC 600 V
- I<sub>F</sub> (Per Leg/Device) 20 A

Benefits

- Unipolar rectifier
- Zero switching loss
- Higher efficiency
- Smaller heat sink
- Parallel devices without thermal runaway

Applications

- Motor drives
- Switch mode power supplies
- Ev chargers
- Solar inverters
- Welding equipment
- Power factor correction
- Diode snubber
- Automotive
- induction heating

Maximum Ratings

Operating Junction Temperature : - 55 °C to +175 °C

Storage Temperature : -55 °C to +175 °C

Part Number	Maximum Recurrent Peak Reverse Voltage	Maximum DC Blocking Voltage
CSR20061P	600V	600V

Maximum Rating Per Leg	Symbol	Conditions	Value	Unit
Continuous forward current	I <sub>F</sub>	T <sub>C</sub> =150 °C	20	A
Surge non-repetitive forward current sine halfwave	I <sub>FSM</sub>	T <sub>C</sub> =25 °C, t <sub>p</sub> =8.3 ms	160	
		T <sub>C</sub> =150 °C, t <sub>p</sub> =8.3 ms	100	
Non-repetitive peak forward current	I <sub>F,max</sub>	T <sub>C</sub> =25 °C, t <sub>p</sub> =10 μs	400	
Repetitive peak reverse voltage	V <sub>RRM</sub>	T <sub>J</sub> =25 °C	600	V

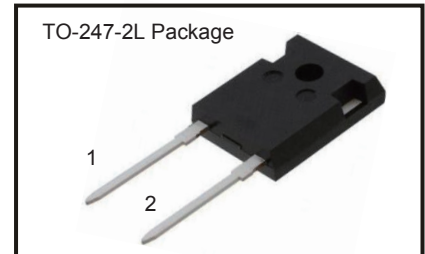

Package Dimensions

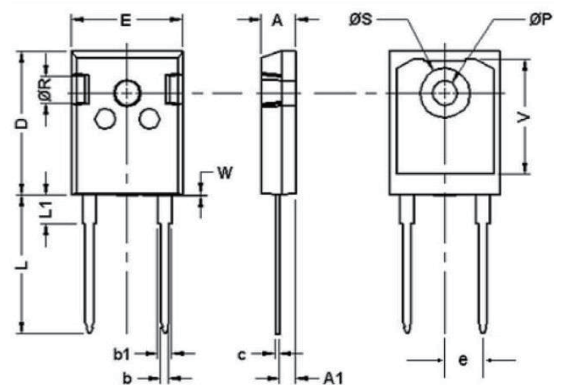

POS	Inches		Millimeters	
	Min	Max	Min	Max
A	0.185	0.209	4.70	5.31
A1	0.087	0.102	2.21	2.59
b	0.040	0.055	1.02	1.40
b1	0.065	0.088	1.65	2.23
C	0.016	0.031	0.41	0.79
D	0.819	0.845	20.80	21.46
E	0.61	0.640	15.49	16.26
e	0.215	0.215	5.46	5.46
L	0.78	0.80	19.81	20.32
L1	0.164	0.176	4.17	4.47
ØP	0.140	0.144	3.56	3.66
Q	0.212	0.244	5.38	6.20
ØR	0.135	0.157	3.43	3.99
ØS	0.278	0.288	7.06	7.32
V	0.652	0.662	16.56	16.81
W	0.000	0.006	0.00	0.15

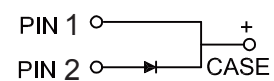



Electrical Characteristics, at  $T_j=25\text{ }^\circ\text{C}$ , unless otherwise specified.

Static Characteristics	Symbol	Conditions	Values			Unit
			min.	typ.	max.	
DC blocking voltage	$V_{DC}$		600	-	-	V
Diode forward voltage	$V_F$	$I_F=20\text{A}, T_j=25\text{ }^\circ\text{C}$	-	1.45	1.65	
		$I_F=20\text{A}, T_j=175\text{ }^\circ\text{C}$	-	1.65	2.00	
Reverse current	$I_R$	$V_R=600\text{V}, T_j=25\text{ }^\circ\text{C}$	-	6	70	$\mu\text{A}$
		$V_R=600\text{V}, T_j=175\text{ }^\circ\text{C}$	-	180	1600	

**AC Characteristics**

Static Characteristics	Symbol	Conditions	Values			Unit
			min.	typ.	max.	
Total capacitive charge	$Q_c$	$V_R=600\text{V}, T_j=25\text{ }^\circ\text{C}$	-	45	-	nC
Total capacitance	C	$V_R=1\text{V}, f=1\text{ MHz}$ $T_j=25\text{ }^\circ\text{C}$	-	1054	-	pF
		$V_R=300\text{V}, f=1\text{ MHz}$ $T_j=25\text{ }^\circ\text{C}$	-	93	-	
		$V_R=600\text{V}, f=1\text{ MHz}$ $T_j=25\text{ }^\circ\text{C}$	-	76	-	

**Thermal Characteristics**

Static Characteristics	Symbol	Values	Unit
		typ.	
Thermal resistance from junction to case	$R_{\theta JC}$	0.77	$^\circ\text{C/W}$



Typical Performance

Forward Characteristics (parameterized on  $T_j$ )

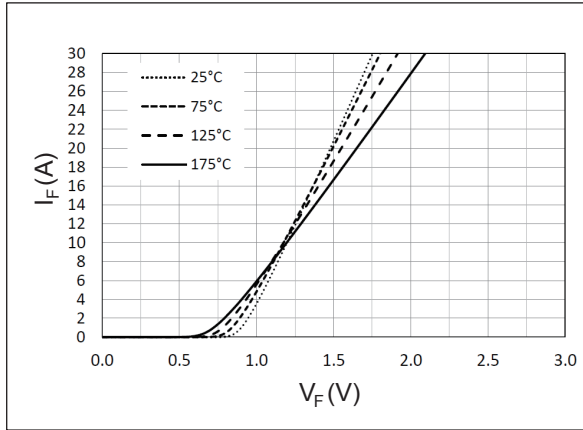

Reverse Characteristics (parameterized on  $T_j$ )

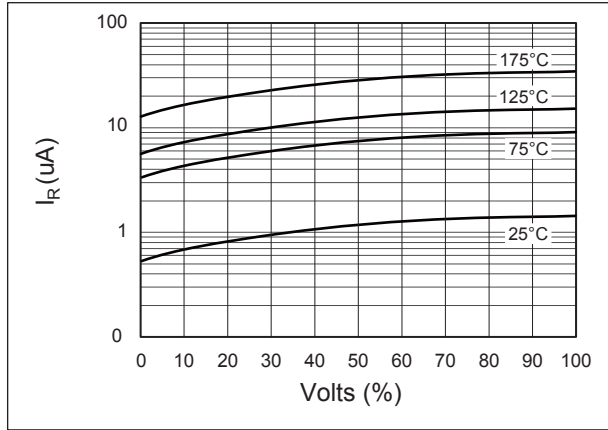

Capacitance

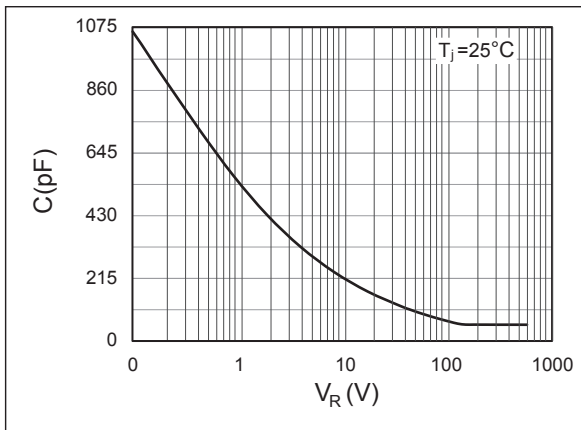

Current Derating

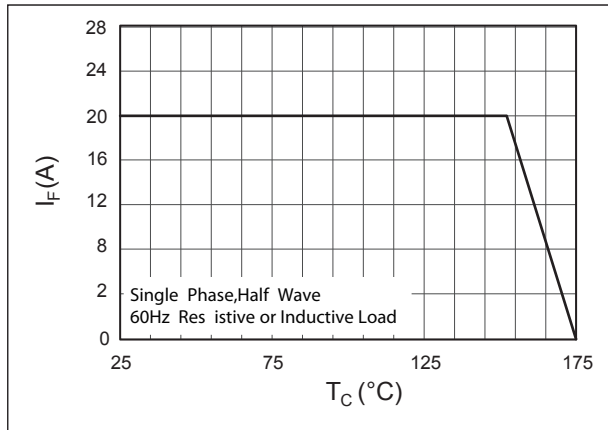

Recovery Charge

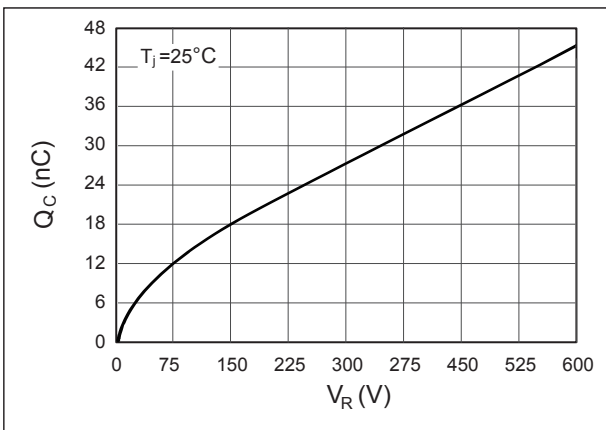

Forward Surge Current

