



SiC SCHOTTKY DIODE TYPE 15A

Features

- High surge current capable
- Zero reverse recovery current
- High bandwidth
- RoHS compliant
- Temperature Independent Switching Behavior
- High temperature soldering guaranteed: 260°C / 10 seconds at terminals
- VDC 1200 V
- I_F (T_c<150°C) 15 A

Benefits

- Unipolar rectifier
- Zero switching loss
- Higher efficiency
- Smaller heat sink
- Parallel devices without thermal runaway

Applications

- Motor drives
- Switch mode power supplies
- Ev chargers
- Solar inverters
- Welding equipment
- Power factor correction
- Diode snubber
- Automotive
- induction heating

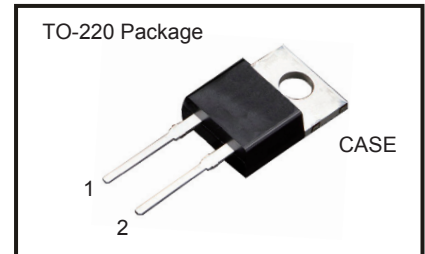

Package Dimensions

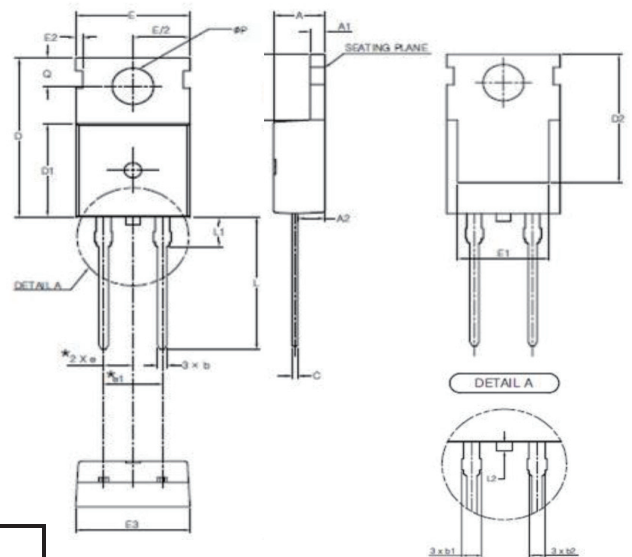

Maximum Ratings

Operating Junction Temperature : - 55 °C to +175 °C
Storage Temperature : -55 °C to +175 °C

Part Number	Maximum Recurrent Peak Reverse Voltage	Maximum DC Blocking Voltage
CSR15121	1200V	1200V

SYMBOL	MIN	NOM	MAX
A	4.30	4.50	4.70
A1	1.25	1.30	1.40
A2	2.20	2.40	2.60
b	0.70	0.80	0.90
b1	1.42	1.52	1.62
b2	1.17	1.27	1.37
c	0.45	0.50	0.60
D	15.50	15.70	15.90
D1	9.00	9.20	9.40
D2		(12.70)	
E	9.00	9.20	9.40
E1		(8.00)	
E2		(0.60)	
E3	9.70	9.90	10.10
e		2.54 BSC	
e1		5.08 BSC	
H1	6.30	6.50	6.70
L	12.88	13.08	13.28
L1		(3.00)	
L2	-	-	0.80
#P	3.50	3.60	3.70
Q	2.70	2.80	2.90

NOTE
1. THESE DIMENSIONS DO NOT INCLUDE PROTRUSIONS OF THE MOLD.
2. THE '()' MARK IS THE REFERENCE
3. THE 'L2' SYMBOL IS A PROTRUSION OF THE MOLD.

Maximum Rating	Symbol	Conditions	Value	Unit
Continuous forward current	I _F	T _C =150 °C	15	A
Surge non-repetitive forward current sine halfwave	I _{FSM}	T _C =25 °C, t _p =8.3 ms	120	
		T _C =150 °C, t _p =8.3 ms	75	
Non-repetitive peak forward current	I _{F,max}	T _C =25 °C, t _p =10 μs	300	
Repetitive peak reverse voltage	V _{RRM}	T _j =25 °C	1200	V

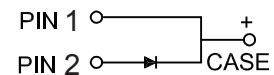



Electrical Characteristics, at $T_j=25\text{ }^\circ\text{C}$, unless otherwise specified.

Static Characteristics	Symbol	Conditions	Values			Unit
			min.	typ.	max.	
DC blocking voltage	V_{DC}		1200	-	-	V
Diode forward voltage	V_F	$I_F=15\text{A}, T_j=25\text{ }^\circ\text{C}$	-	1.6	1.8	
		$I_F=15\text{A}, T_j=175\text{ }^\circ\text{C}$	-	2.2	2.7	
Reverse current	I_R	$V_R=1200\text{V}, T_j=25\text{ }^\circ\text{C}$	-	3	30	μA
		$V_R=1200\text{V}, T_j=175\text{ }^\circ\text{C}$	-	90	900	

AC Characteristics

Static Characteristics	Symbol	Conditions	Values			Unit
			min.	typ.	max.	
Total capacitive charge	Q_C	$V_R=1200\text{V}, T_j=25\text{ }^\circ\text{C}$	-	65	-	nC
Total capacitance	C	$V_R=1\text{V}, f=1\text{ MHz}$ $T_j=25\text{ }^\circ\text{C}$	-	952	-	pF
		$V_R=600\text{V}, f=1\text{ MHz}$ $T_j=25\text{ }^\circ\text{C}$	-	56	-	
		$V_R=1200\text{V}, f=1\text{ MHz}$ $T_j=25\text{ }^\circ\text{C}$	-	54	-	

Thermal Characteristics

Static Characteristics	Symbol	Values	Unit
		typ.	
Thermal resistance from junction to case	$R_{\theta JC}$	0.53	$^\circ\text{C/W}$



Typical Performance

Forward Characteristics (parameterized on T_j)

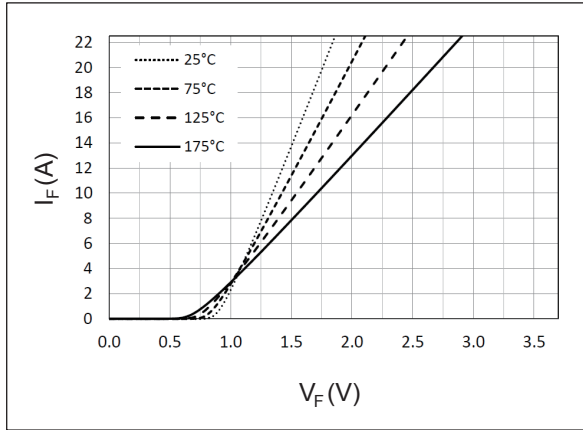

Reverse Characteristics (parameterized on T_j)

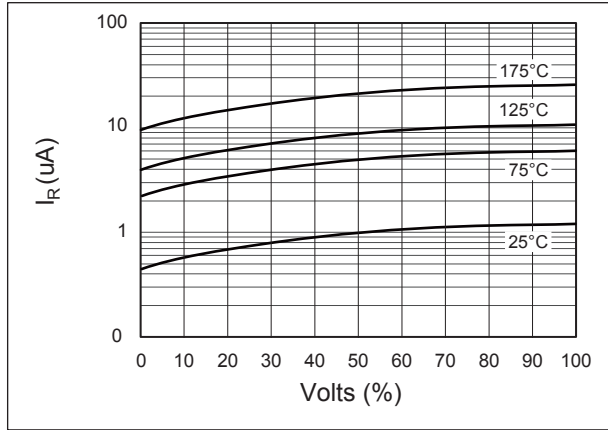

Capacitance

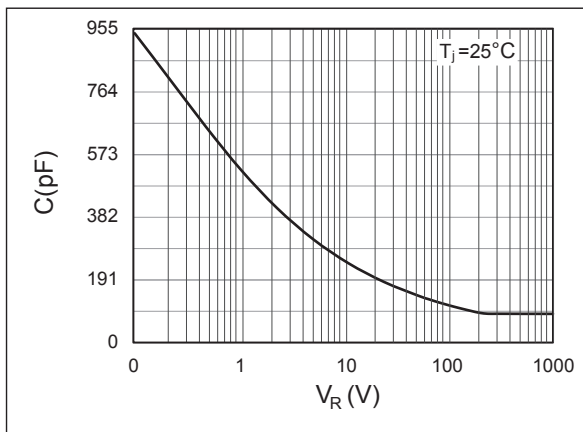

Current Derating

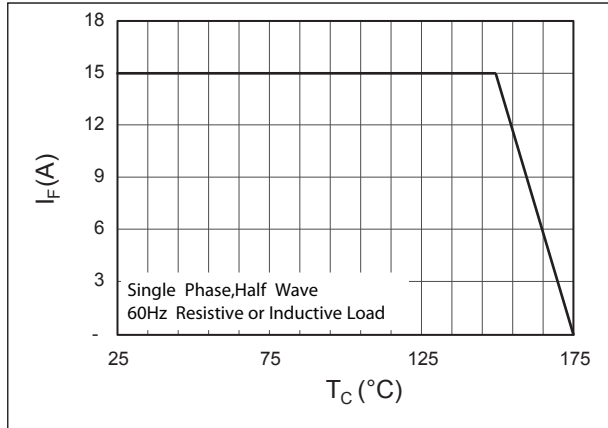

Recovery Charge

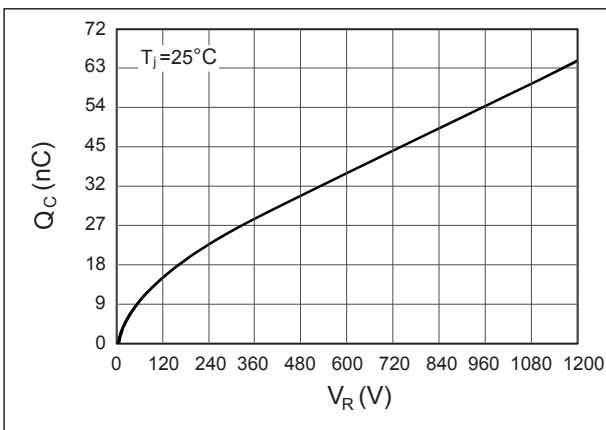

Forward Surge Current

