



SiC SCHOTTKY DIODE TYPE 6A

Features

- High surge current capable
- Zero reverse recovery current
- High bandwidth
- RoHS compliant
- Temperature Independent Switching Behavior
- High temperature soldering guaranteed: 260°C / 10 seconds at terminals
- VDC 600 V
- I<sub>F</sub> (T<sub>c</sub><150°C) 6 A

Benefits

- Unipolar rectifier
- Zero switching loss
- Higher efficiency
- Smaller heat sink
- Parallel devices without thermal runaway

Applications

- Motor drives
- Switch mode power supplies
- Ev chargers
- Solar inverters
- Welding equipment
- Power factor correction
- Diode snubber
- Automotive
- induction heating

Maximum Ratings

Operating Junction Temperature : - 55 °C to +175 °C  
 Storage Temperature : -55 °C to +175 °C

Part Number	Maximum Recurrent Peak Reverse Voltage	Maximum DC Blocking Voltage
CSR06061	600V	600V

Maximum Rating	Symbol	Conditions	Value	Unit
Continuous forward current	I <sub>F</sub>	T <sub>C</sub> =150 °C	6	A
Surge non-repetitive forward current sine halfwave	I <sub>FSM</sub>	T <sub>C</sub> =25 °C, t <sub>p</sub> =8.3 ms	48	
		T <sub>C</sub> =150 °C, t <sub>p</sub> =8.3 ms	30	
Non-repetitive peak forward current	I <sub>F,max</sub>	T <sub>C</sub> =25 °C, t <sub>p</sub> =10 μs	120	
Repetitive peak reverse voltage	V <sub>RRM</sub>	T <sub>J</sub> =25 °C	600	V

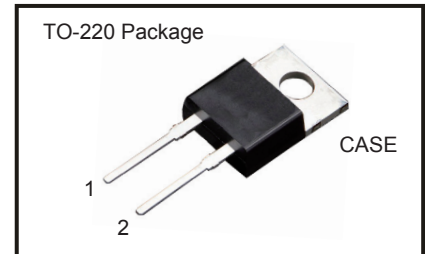

Package Dimensions

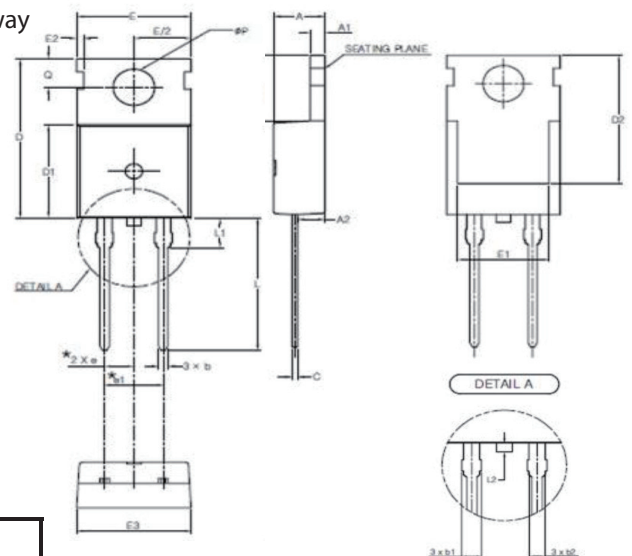

SYMBOL	MIN	NOM	MAX
A	4.30	4.50	4.70
A1	1.25	1.30	1.40
A2	2.20	2.40	2.60
b	0.70	0.80	0.90
b1	1.42	1.52	1.62
b2	1.17	1.27	1.37
c	0.45	0.50	0.60
D	15.50	15.70	15.90
D1	9.00	9.20	9.40
D2	(12.70)		
E	9.00	9.20	9.40
E1	(8.00)		
E2	(0.60)		
E3	9.70	9.90	10.10
e	2.54 BSC		
e1	5.08 BSC		
H1	6.30	6.50	6.70
L	12.88	13.08	13.28
L1	(3.00)		
L2	-	-	0.80
phi P	3.50	3.60	3.70
Q	2.70	2.80	2.90

NOTE

1. THESE DIMENSIONS DO NOT INCLUDE PROTRUSIONS OF THE MOLD.
2. THE "( )" MARK IS THE REFERENCE
3. THE "L2" SYMBOL IS A PROTRUSION OF THE MOLD.

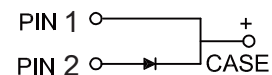



Electrical Characteristics, at  $T_j=25\text{ }^\circ\text{C}$ , unless otherwise specified.

Static Characteristics	Symbol	Conditions	Values			Unit
			min.	typ.	max.	
DC blocking voltage	$V_{DC}$		600	-	-	V
Diode forward voltage	$V_F$	$I_F=6A, T_j=25\text{ }^\circ\text{C}$	-	1.45	1.65	
		$I_F=6A, T_j=175\text{ }^\circ\text{C}$	-	1.65	2.00	
Reverse current	$I_R$	$V_R=600V, T_j=25\text{ }^\circ\text{C}$	-	2	20	$\mu A$
		$V_R=600V, T_j=175\text{ }^\circ\text{C}$	-	50	480	

### AC Characteristics

Static Characteristics	Symbol	Conditions	Values			Unit
			min.	typ.	max.	
Total capacitive charge	$Q_c$	$V_R=600V, T_j=25\text{ }^\circ\text{C}$	-	14	-	nC
Total capacitance	C	$V_R=1V, f=1\text{ MHz}$ $T_j=25\text{ }^\circ\text{C}$	-	316	-	pF
		$V_R=300V, f=1\text{ MHz}$ $T_j=25\text{ }^\circ\text{C}$	-	28	-	
		$V_R=600V, f=1\text{ MHz}$ $T_j=25\text{ }^\circ\text{C}$	-	23	-	

### Thermal Characteristics

Static Characteristics	Symbol	Values	Unit
		typ.	
Thermal resistance from junction to case	$R_{\theta JC}$	2.3	$^\circ\text{C/W}$



Typical Performance

Forward Characteristics (parameterized on  $T_j$ )

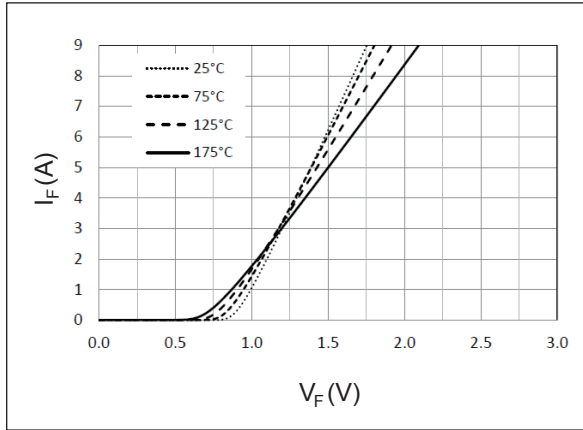

Reverse Characteristics (parameterized on  $T_j$ )

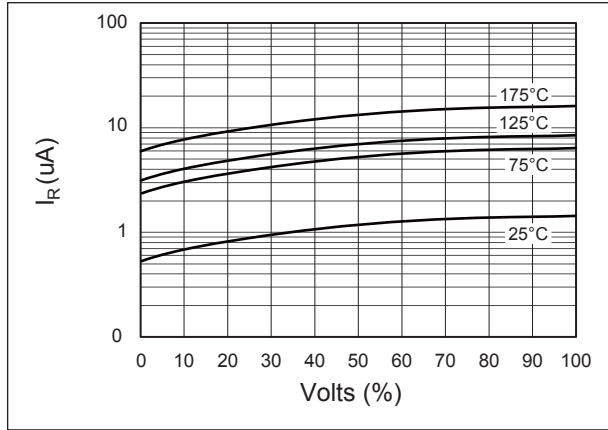

Capacitance

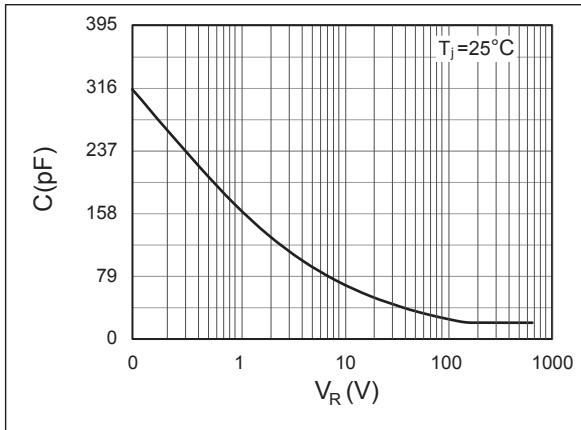

Current Derating

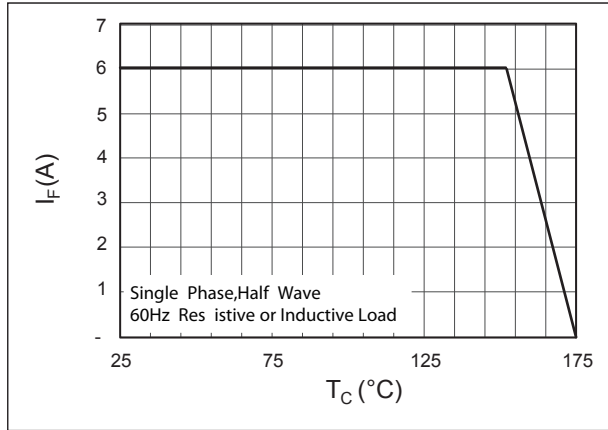

Recovery Charge

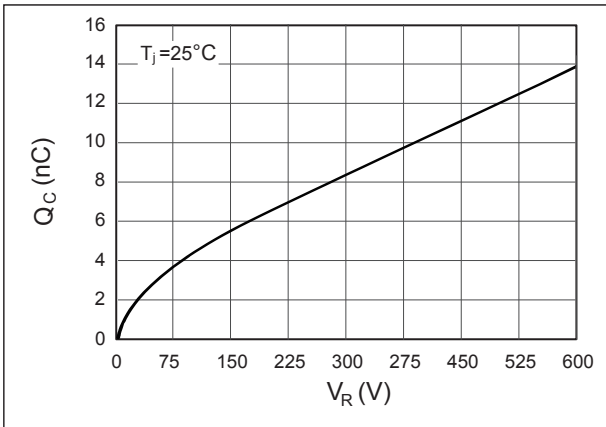

Forward Surge Current

