



## IGBT Module 600V / 75A

### Features

- ◆ Fast switching IGBT trench technology
- ◆ Low switching loss
- ◆ Superfast diodes
- ◆ High short circuit capability

### Applications

- ◆ Welder / Power Supply
- ◆ UPS / Inverter
- ◆ Industrial Motor Drive

Preliminary

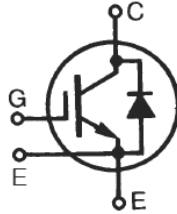

### SOT-227

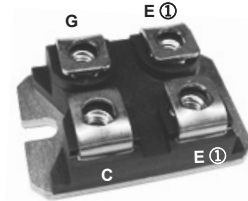

G = Gate, C = Collector, E = Emitter  
 ① either emitter terminal can be used as Main or Kelvin Emitter

Dimensions in inches and (millimeters)

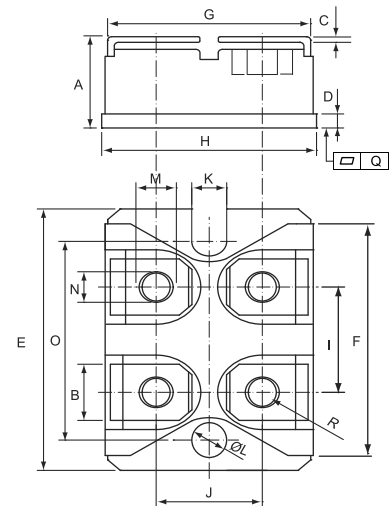

### Maximum Ratings (T<sub>c</sub> = 25°C)

Item	Symbol	Rated Value	Unit
Collector-Emitter Voltage	V <sub>CES</sub>	600	V
Gate-Emitter Voltage	V <sub>GES</sub>	±20	V
DC-Collector Current	I <sub>C,nom.</sub>	75	A
Repetitive Peak Collector Current	I <sub>CRM</sub>	150	A
Total Power Dissipation	P <sub>tot</sub>	315	W
Isolation Voltag (e Terminal to Base, AC 1 min.)	V <sub>iso</sub>	2500	V
DC Forward Current	I <sub>F</sub>	75	A
Repetitive Peak Forward. Current	I <sub>FRM</sub>	150	A
Junction Temperature Range	T <sub>J</sub>	-40~+150	°C
Storage Temperature Range	T <sub>stg</sub>	-40~+125	°C
Mounting Torque (M4 Screw)	M <sub>d</sub>	1.3	N.m

	DIMENSIONS			
	INCHES		MM	
	MIN	MAX	MIN	MAX
A	0.460	0.483	11.68	12.28
B	0.307	0.323	7.80	8.20
C	0.030	0.033	0.75	0.85
D	0.071	0.081	1.80	2.05
E	1.488	1.504	37.80	38.20
F	1.248	1.260	31.70	32.00
G	0.917	0.957	23.30	24.30
H	0.996	1.008	25.30	25.60
I	0.579	0.602	14.70	15.30
J	0.492	0.516	12.50	13.10
K	0.161	0.169	4.10	4.30
L	0.161	0.169	4.10	4.30
M	0.181	0.197	4.60	5.00
N	0.165	0.181	4.20	4.60
O	1.181	1.197	30.00	30.40
Q	-0.002	0.004	-0.05	0.10
R	M4*8			



■ **Electrical Characteristics** (  $T_{VJ} = 25^{\circ}\text{C}$  )

Characteristic		Symbol	Test Conditions	Min.	Typ.	Max.	Unit
Collector-Emitter Cut-Off Current		$I_{CES}$	$V_{CE}=600\text{V}$ $V_{GE}=0\text{V}$	-	1	500	$\mu\text{A}$
Gate-Emitter Leakage Current		$I_{GES}$	$V_{GE}=20\text{V}$ $V_{CE}=0\text{V}$	-	-	400	nA
Collector-Emitter Saturation Voltage		$V_{CE(sat)}$	$I_C=75\text{A}, V_{GE}=15\text{V}$	-	1.95	2.45	V
Gate-Emitter Threshold Voltage		$V_{GE(th)}$	$V_{CE}=V_{GE}, I_C=1.5\text{mA}$	4.5	5.5	6.5	V
Input Capacitance		$C_{ies}$	$V_{CE}=25\text{V}, V_{GE}=0\text{V}, f=1\text{MHz}$	-	6.0	-	nF
Output Capacitance		$C_{oes}$	$V_{CE}=25\text{V}, V_{GE}=0\text{V}, f=1\text{MHz}$	-	0.52	-	nF
Reverse Transfer Capacitance		$C_{res}$	$V_{CE}=25\text{V}, V_{GE}=0\text{V}, f=1\text{MHz}$	-	0.24	-	nF
Switching Time	Rise Time	$t_r$	$V_{CC}=300\text{V}$ $I_C=75\text{A}$ $R_G=3\Omega$ $V_{GE}=\pm 15\text{V}$	-	60	-	ns
	Turn-On Time	$t_{d,on}$		-	85	-	
	Fall Time	$t_f$		-	67	-	
	Turn-Off Time	$t_{d,off}$		-	128	-	
Turn-on Energy Loss Per Pulse		$E_{on}$	$I_C=75\text{A}, V_{CC}=300\text{V}$ $V_{GE}=15\text{V}, R_G=3\Omega$	-	0.35	-	mJ
Turn-off Energy Loss Per Pulse		$E_{off}$	$T_{VJ}=25^{\circ}\text{C}, L_S=15\text{nH}$	-	1.9	-	mJ

■ **Free Wheeling Diode Ratings & Characteristics** (  $T_{VJ} = 25^{\circ}\text{C}$  )

Characteristic		Symbol	Test Conditions	Min.	Typ.	Max.	Unit
Peak Forward Voltage		$V_F$	$I_F=75\text{A}, V_{GE}=0\text{V}$	-	1.8	2.5	V
Peak Reverse Recovery Current		$I_{RM}$	$I_F=75\text{A}, R_G=3\Omega$ $V_R=300\text{V}, V_{GE}=-15\text{V}$	-	33	-	A
Recovered Charge		$Q_r$	$I_F=75\text{A}, R_G=3\Omega$ $V_R=300\text{V}, V_{GE}=-15\text{V}$	-	1.58	-	$\mu\text{C}$
Reverse Recovery Energy		$E_{rec}$	$I_F=75\text{A}, R_G=3\Omega$ $V_R=300\text{V}, V_{GE}=-15\text{V}$	-	0.39	-	mJ
Reverse Recovery Time		$T_{rr}$	$I_F=75\text{A}, R_G=3\Omega$ $V_R=300\text{V}, V_{GE}=-15\text{V}$	-	81	-	ns

■ **Thermal Characteristics** (  $T_C=25^{\circ}\text{C}$  )

Characteristic		Symbol	Test Conditions	Min.	Typ.	Max.	Unit
Thermal Impedance	IGBT	$R_{th(j-c)}$	Junction to Case	-	-	0.35	$^{\circ}\text{C/W}$
	Diode			-	-	0.60	



Typical Characteristics

Preliminary Data

Fig.1 Output characteristic (Typical)

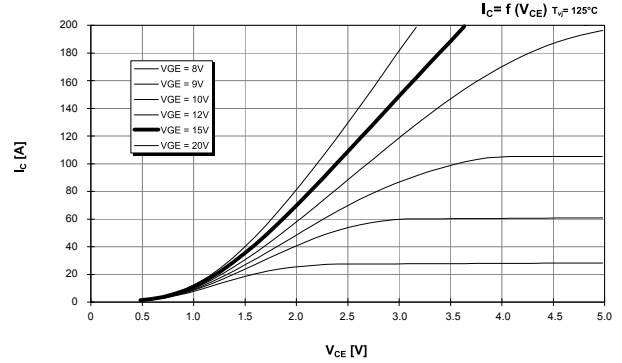
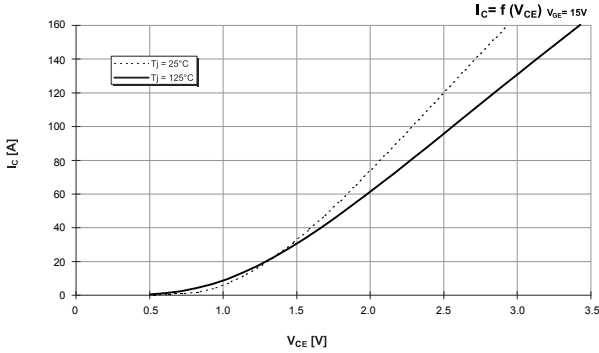

Fig.2 Transfer characteristic (Typical)

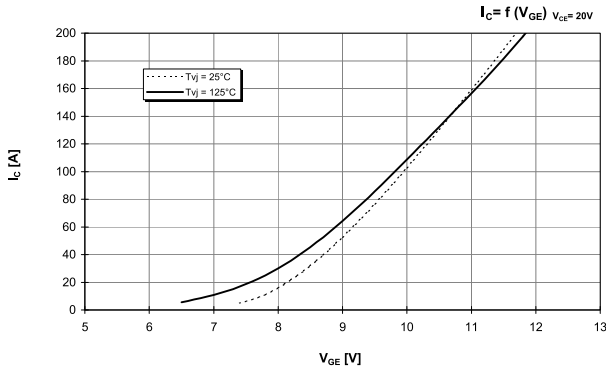

Fig.3 Forward characteristic of inverse diode (typical)

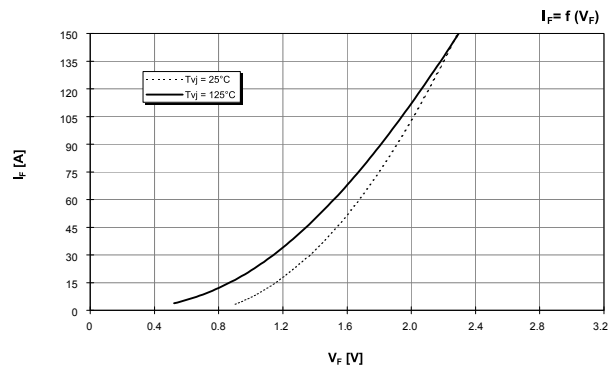

Fig.4 Switching losses (Typical)

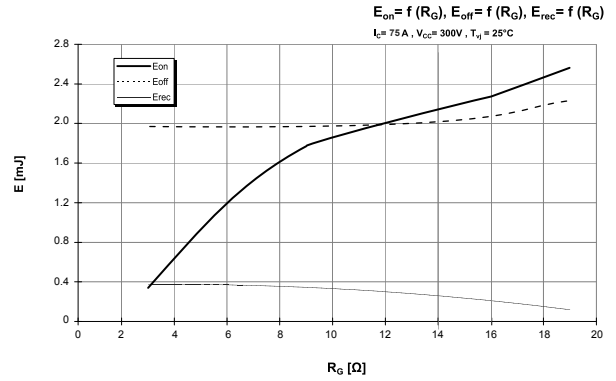
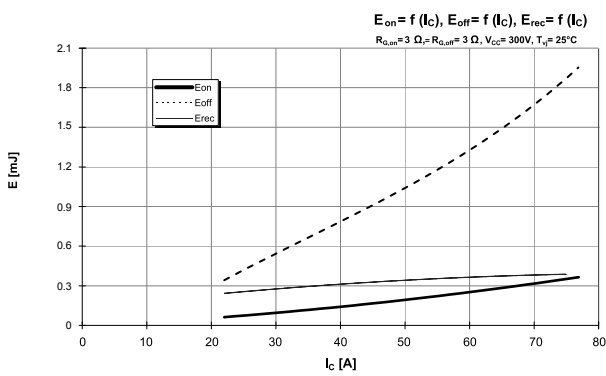

Fig.5 Transient thermal impedance

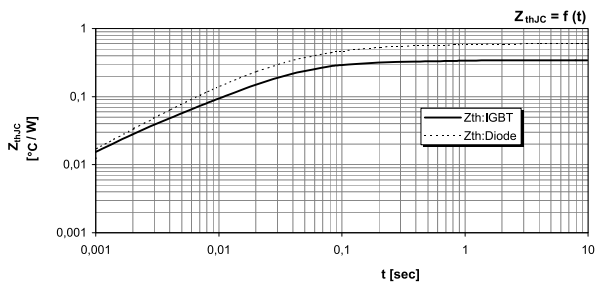
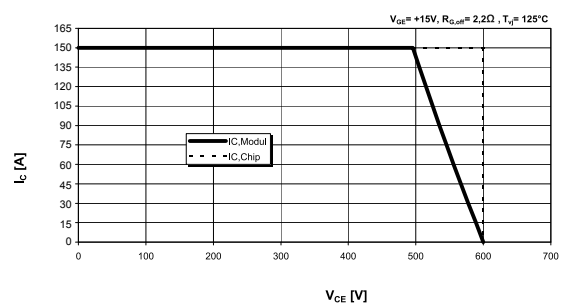

Fig.6 Reverse bias safe operation area (RBSOA)





### **Disclaimer**

DACO Semiconductor reserve the right to make modifications, enhancements, improvements, corrections or other changes without further notice to this document and any product described herein.

DACO Semiconductor makes no warranty, representation or guarantee regarding the suitability of its products for any particular purpose, nor does DACO Semiconductor assume any liability arising out of the application or use of any product or circuit, and specifically disclaims any and all liability, including without limitation special, consequential or incidental damages.

Purchasers is responsible for its products and applications using DACO Semiconductor products, including compliance with all laws, regulations and safety requirements or standards, regardless of any support or applications information provided by DACO Semiconductor. "Typical" parameters which may be provided in DACO Semiconductor data sheets and/or specifications can and do vary in different applications and actual performance may vary over time. All operating parameters, including "Typicals" must be validated for each customer application by customer's technical experts.

DACO Semiconductor products are not designed, authorized or warranted to be suitable for use in life support, life-critical or safety-critical systems or equipment, nor in applications where failure or malfunction of DACO Semiconductor's product can reasonably be expected to result in personal injury, death or severe property or environmental damage. DACO Semiconductor accept no liability for inclusion and/or use of DACO Semiconductor's products in such equipment or applications and therefore such inclusion and/or use is at the customer's own risk.

Purchasers buy or use DACO Semiconductor products for any such unintended or unauthorized application, Purchasers shall indemnify and hold DACO Semiconductor and its suppliers and distributors harmless against all claims, costs, damages, and expenses, and reasonable attorney fees arising out of, directly or indirectly, any claim of personal injury or death associated with such unintended or unauthorized use, even if such claim alleges that DACO Semiconductor was negligent regarding the design or manufacture of the part.

No part of this publication may be reproduced or transmitted in any form or by any means, electronic or mechanical, including photocopying and recording, or any information storage or retrieval system, or otherwise, without the prior written permission of DACO Semiconductor Co., Ltd.